

A Very Low Velocity Measurement Using Ultrasonic Velocimetry

Tomonori Ihara, Hiroshige Kikura, Yasushi Takeda

Research Laboratory for Nuclear Reactors, Tokyo Institute of Technology, N1-7, 2-12-1 Ookayama,
Meguro-ku, Tokyo, 152-8550, Japan

Address: ihara@us.nr.titech.ac.jp

In order to measure a very low velocity using UVP, the conventional algorithm of signal processing could not be applied because of the lower velocity limitation. Recently, phase difference method was proposed to overcome this limitation. However, the characteristics of this method are not yet fully investigated, and we studied them in this paper. Firstly, a measurement system was constructed using digital signal processing technique. Secondly, measurement limitation of the system at a very low velocity was investigated using wall-reflected signals. Finally, real time profile measurement was demonstrated with the flow in a rotating cylinder, and measurement accuracy was also discussed.

Keywords: Very Slow Flow, Phase Difference Method, Accuracy Verification

1 INTRODUCTION

Isolation of High Level Radioactive Wastes (HLWs) from biosphere and its disposition in a deep geological repository is an urgent problem and vitrification technique of HLW has to be improved in the industrial scale. This vitrification melter is operated with internal Joule-heat generation, and the temperature of glass exceeds 1000°C. For understanding a thermal hydraulics behavior of the vitrification melter, experimental technique has to be invented. Several velocity measurement techniques such as PIV/PTV, LDA had been developed. However, because of high temperature and opaqueness, these techniques cannot be applied for glass melts. To overcome these difficulties, we focused ourselves on UVP technique[1]. Realization of such a technique has difficulties in two fold; high temperature and very low velocity. We already demonstrated ultrasonic measurement technique inside glass melts employing buffer-rod [2]. In this paper, we present a system developed to measure an extremely low velocity flow.

Many methods have been presented to calculate velocity from pulsed-echo signals, and most widely-used method is Doppler frequency determination technique. In this technique, FFT or Zero-crossing counter is often used to estimate Doppler-shift frequency from echo sequence (typically, a number of repetition pulses is over 100.). Recently, the phase difference method was proposed for a low velocity measurement [3-4]. This technique detects the phase of the ultrasonic carrier frequency directly from the echo signal, and determines its difference between two successive echo receptions. Then, velocity is calculated from the phase difference. Since this technique basically needs only two times of echo reception, it can provide a higher temporal resolution than conventional methods. However, the low limit of speed by this method is not fully investigated.

2 IMPLEMENTATION

In this section, velocity calculation procedures of conventional method and phase difference method are described. FFT based method [5] is employed as a conventional method, and compared with phase difference method in this work. All signal processing were performed digitally on LabVIEW.

2.1 FFT Based Doppler Method

Fig.1 shows a schematic block diagram of this FFT method. The procedure can be divided into 2 parts; quadrature demodulation and frequency analysis. In the diagram, digitized echo signal is expressed as d_{ij} where the subscript i denotes channel index, and j denotes repetition index. In order to distinguish the Doppler signal, echo signals of each channel are demodulated to in-phase and quadrature phase with reference signal, which has the same center frequency f_0 as the transmitted signal. After complex FFT is carried out for each phase, power spectra of forward direction and backward direction are obtained as P_f and P_b respectively. Finally, the Doppler-shift frequency f_{Di} and flow direction are determined by their peak value. Therefore, flow velocity V_i is calculated as Eq. (1).

$$V_i = \frac{f_{Di}}{2f_0} c \quad (1)$$

where c is sound speed in the fluid. Because a spectrum is calculated at discrete points, velocity values have limitations as follows:

$$V_{\max} = \frac{f_{PRF}}{4f_0} c \quad (2)$$

$$V_{\text{step}} = \frac{f_{PRF}}{N_j f_0} c \quad (3)$$

where f_{PRF} is a pulse repetition frequency, and N_j is a number of pulse emissions. Practically, the peak of

the spectra is calculated from three point Gaussian curve fitting to improve the velocity resolution. Nevertheless, this V_{step} could be equal to the lower velocity limitation.

Since this technique does not require high speed ADC, it has been widely used. However, there is a trade-off relationship between temporal and velocity resolutions depending on N_j . The temporal resolution ΔT can be expressed as Eq. (4).

$$\Delta T = \frac{N_j}{f_{PRF}} \quad (4)$$

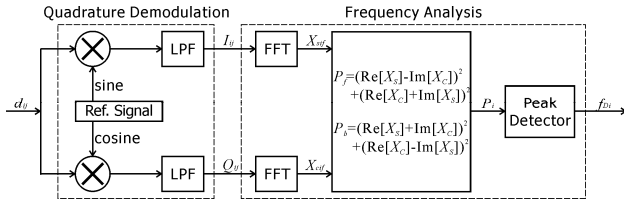

Figure 1: Schematic block diagram of FFT based Doppler method.

2.2 Phase Difference Method

Fig.2 shows a schematic block diagram of this method. The echo signal is sampled with ADC which has more than twice higher sampling rate than center frequency of the emission pulse to fulfill Nyquist theorem, and consequently each channel has many sampled values. In the diagram, the subscript k is added sampling index, and signal is expressed as d_{ijk} . In order to calculate the phase of the signal, complex FFT function X_{ijf} is computed where f is the frequency index. From conjugate complex product of two successive functions, phase difference $\Delta\theta$ is obtained. Therefore, flow velocity V_{ij} is calculated as Eq. (5).

$$V_{ij} = \frac{f_{PRF}}{4\pi f_0} c \cdot \Delta\theta_{ij} \quad (5)$$

For calculating the velocity, the number which indicates the center frequency f_0 is usually selected as frequency index f . If they are not equal, an estimated phase has a leakage induced error [6].

Since this technique can calculate velocity from two echoes, the temporal resolution of this method can be expressed as Eq. (6).

$$\Delta T = \frac{2}{f_{PRF}} \quad (6)$$

As for V_{max} , it is equal to Eq. (2) because the range of $\Delta\theta$ remains between $-\pi$ and π .

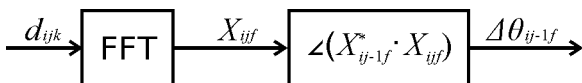

Figure 2: Schematic block diagram of phase difference method.

3 VERIFICATIONS OF LOW LIMIT OF MEASUREMENT SPEED

3.1 Configuration

To examine the low limit speed of phase difference method, a wall-reflected echo signal was used. Fig.3 shows a schematic illustration of the experimental setup. A PZT composite transducer, which has a center frequency of 2MHz and an element diameter of 20mm (2k20N, Japan Probe Co., Ltd), was immersed in a water of 30°C and fixed on the stage. Measurement axis is perpendicular to the wall. The stage moves toward the wall at a constant speed. Motion speeds are controlled by PC from 0.0012 to 5 mm/s. To discriminate the echoes from front-wall and back-wall, the reflector acrylic block has a thickness of 100mm. A pulser/receiver (JPR-10CN, Japan Probe Co. Ltd) was used to generate the ultrasonic tone burst pulse and to receive the echo signal. The signal is sampled by the digitizer (PXI-5105, National Instruments Inc.).

Tab.1 shows measurement configuration. Applied voltage and gain is chosen such that echo amplitude from the wall is almost equal to the full scale of digitizer input range. During the transducer motion at a constant speed, 7680 reputational waveforms are stored. Velocity calculations are performed off-line using the same signal data to evaluate the difference of signal processing method between FFT method and phase difference method. With FFT method, one velocity profile is calculated from 128 waveforms and hence 60 profiles are obtained. The mid-point of each channel is used to calculate FFT signal. As phase difference method needs two waveforms for calculation, 7679 profiles are obtained. Erroneous velocity information is also included in the profile, which is caused by multipath reflections between wall and transducer, or inside wall. To remove these errors, a velocity is extracted from those whose original signal amplitude is higher than 80% in full scale. Therefore, measured velocities are determined from ensemble average of these profiles.

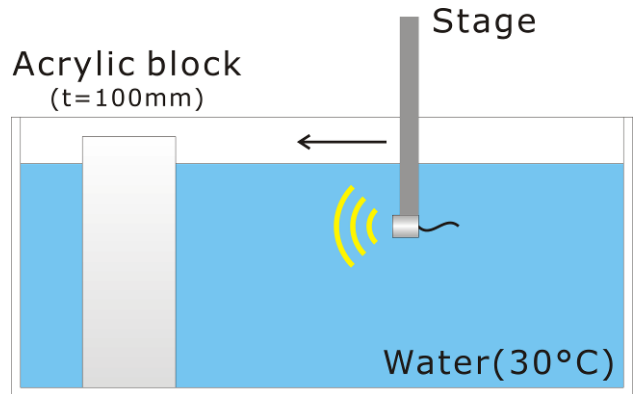

Figure 3: Schematic illustration of experimental setup

Table 1: Signal collection configuration

| Pulser/Receiver | |
|--------------------------------------|----------------|
| Basic Frequency f_0 | 2MHz |
| Pulse Repetition Frequency f_{PRF} | 100,500,1000Hz |
| Burst Cycle | 8 |
| Applied Voltage | 50V |
| Gain | +40dB |
| Digitizer | |
| Sampling Speed | 60MS/s |
| Number of Channels N_i | 140chs |
| Number of Repetitions N_j | 128 |
| Number of Samples N_k | 60/ch |
| Number of Stored Signals | 7680 |
| AD bit lengths | 12bits |
| Vertical Input Range | 1V |

3.2 Results and Discussion

Figs. 4-6 show measured results of phase difference method and FFT method in different PRF. Vertical broken lines indicate the lower velocity limit of FFT method which is derived from Eq. (3). Equivalent phase difference is given at the top.

Measurement errors of FFT method remained under 10% when the motion speed is over half of their lower limits, and yet errors became bigger. From this result, we conclude that Gaussian interpolation improved velocity accuracy, but it was not sufficient to measure a sub mm/s velocity.

On the other hand, the error of phase difference method remains under 10% down to ca. 10^{-2} mm/s in Fig. 4. As shown in the other figures, it can be concluded that overall accuracy was within 10% when phase difference is over 10^{-3} rad. This might be an effective limit with this setup. As we used the 12bits digitizer, phase resolution can be considered as 1.5×10^{-3} rad., and it shows good agreement with the experiment. It indicates that one needs to use slower pulse repetition or a digitizer having higher resolution for improving the measurement accuracy.

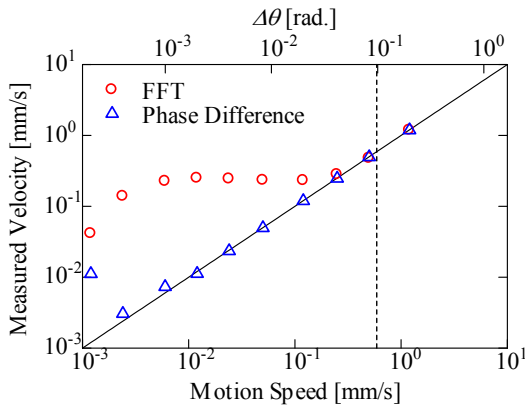

Figure 4: Measured velocity versus motion speed for FFT method and phase difference method ($f_{PRF}=100$ Hz)

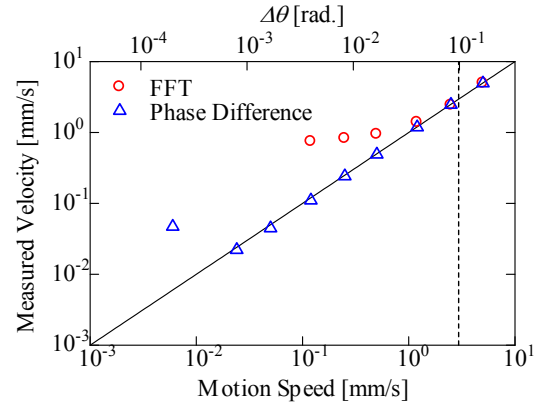

Figure 5: Measured velocity versus motion speed for FFT method and phase difference method ($f_{PRF}=500$ Hz)

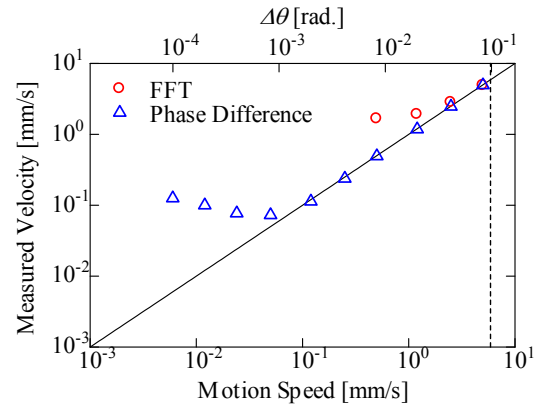

Figure 6: Measured velocity versus motion speed for FFT method and phase difference method ($f_{PRF}=1000$ Hz)

4 FLOW MEASUREMENTS INSIDE A ROTATING CYLINDER

4.1 Configuration

We constructed an UVP system employing phase difference method. In this section, flow measurement using tracer particle inside a rotating cylinder is demonstrated using phase difference method. Fig. 7 shows schematic of experimental set up. The acrylic rotating cylinder has an outer diameter of 160mm and a wall thickness of 3mm. The cylinder is set up in the water tank and its temperature is controlled to 30°C. Nylon 12 particle (WS-200P, Daicel-Evonik Ltd.; an average size is 80 μ m, and specific density is 1.02) is used as the tracer particle. To match the tracer and fluid density, 10wt% glycerol/water solution is filled inside the cylinder, and its sound speed was 1550 m/s. The stepping motor is mounted underneath the tank and drives the cylinder directly. Ultrasonic transducer of 4MHz basic frequency and 5mm element diameter is fixed at the position $L = 2.5$ mm in Fig. 7. The same pulser/receiver and the digitizer were employed as the previous chapter. Pulse repetition frequency (f_{PRF}) is fixed to 500Hz, applied voltage is 100V, and burst cycle is 4 times. Echo signals are sampled with 20MHz and number of samples N_k is

20 for each channel and total channel number N_i is 240. Vertical input range is 200mV. Other parameters are the same in Tab. 1.

Although the minimum temporal resolution of phase difference method can be described as Eq. (6), it is limited by bottlenecks such as data transfer (bandwidth) from digitizer to PC, computation speed. To realize real time measurement, several successive signals are processed to calculate a velocity profile and the next acquisition and transfer must wait for the previous calculation. So, signals between their processing will be discarded. In this experiment, we used 128 repetitional signals for each profile calculation (duration is 64 μ s) and total processing times between profiles were ca. 280 μ s. using core i5 M460 (2.53GHz) PC.

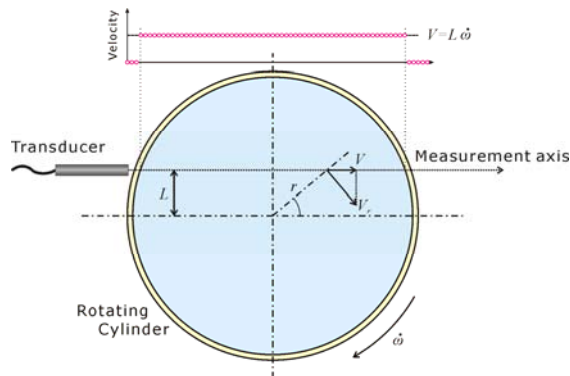

Figure 7: Schematic illustration of rotating cylinder, transducer position, and ideal measurement result for steady rigid-body flow.

4.2 Results and Discussion

Fig. 8 shows a color density plot of the measured results when the cylinder starts rotation by 30rpm. As shown in the plot, in the near-wall region fluid is accelerated by the shear stress by the container at $t=0$. Velocities become constant along the fluid region like Fig. 7 as the stress diffuses to the center. We could confirm that phase difference method can be applied to observe the transient behaviour quite well from this result.

Fig. 9 shows an averaged velocity profile between $t=200-300$ s. Although velocities of the far half seem to contain some error because signal is disturbed by multiple reflections inside the container, measurement errors of the front half were less than 5% from the theoretical value.

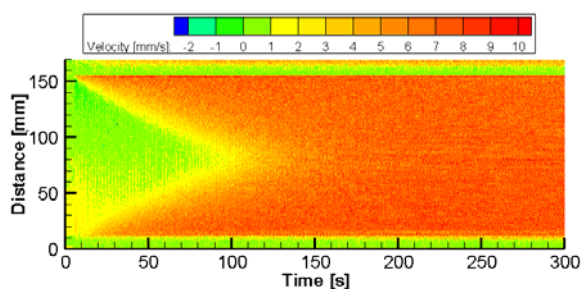

Figure 8: Measured flow map inside the spinning-up rotating cylinder.

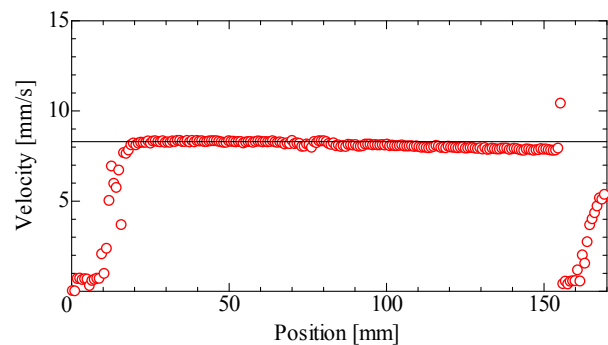

Figure 9: Averaged velocity profile after the flow is fully developed.

5 SUMMARY

The verification and application of phase difference method were demonstrated in this paper. The real time measurement system was also constructed employing pulser/receiver, high speed digitizer, and signal processing on LabVIEW.

Using a wall-reflected echo, we validated the measurement accuracy of the velocity values by the phase difference method down around 1 μ m/s. As a result, it was concluded that overall accuracy was within 10% when phase difference is over 10-3 rad., which is lower than conventional method by one order of magnitude.

A flow inside a rotating cylinder was also measured. It showed good performance of phase difference method for measuring the velocity profile using an echo signal from tracer particle. The flow measurement accuracy is also discussed, and its error was less than 5%.

Other measurement result will be also presented in the presentation.

REFERENCES

- [1] Takeda Y: Measurement of velocity profile of mercury flow by ultrasound Doppler shift method, Nucl. Technol. 79 (1987), 120-124.
- [2] Ihara T., Kikura H. et al.: Ultrasound characteristics in high-temperature fluid, Proc. 8th ASME-JSME Therm. Eng. Joint Conf. (2011-3), AJTEC2011-44243.
- [3] Kitaura H., Tadada Y., et al.: A new algorithm for low velocity measurement by UVP, Proc. 4th ISUD, (2004-9), 121-124.
- [4] Ihara T., Kikura H. et al.: The study of measurement for a very slow flow using phase difference method, IEICE Technical Report 112 (2012), 7-11 (in Japanese).
- [5] Aydin N. and Evans D.H.: Implementation of directional Doppler techniques using a digital signal processor, Med. Biol. Eng. Comput. 32 (1994), 157-164.
- [6] Dishan H.: Phase error in fast Fourier transform analysis, Mech. Sys. Sig. Proc. 9 (1995), 113-118.